

## QY-P003-S-V11

- 5\*COM,6\*USB2.0, 2\*Gigabit LAN
- 1\*LVDS/eDP, 1\*HDMI,1\*VGA
- 1\*Mini-PCle (4G/Wifi/BT)
- 1\*M.2 3052 Key-B
- 1\*M-SATA
- DC 12V Power Input

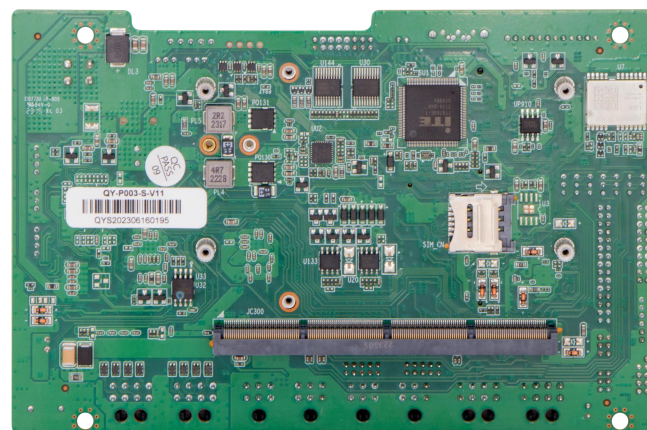
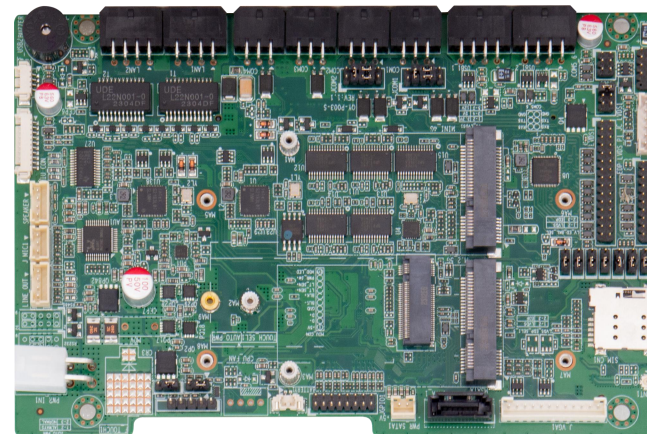

## 1. Specification

<b>Model</b>	<b>QY-P003-S-V11</b>
<b>Storage</b>	1 * SATA3.0 7P Connector 1 * Mini-SATA
<b>Expansion Interface</b>	1 * Mini-PCIe ( Wifi supported with 4G/BT selectable) 1 * M.2 3052 Key-B ( 5G supported)
<b>Ethernet</b>	2 * Intel® 2.5Gbps PCIe Ethernet Controller, RJ45
<b>Audio</b>	Realtek® HDA Codec, with MIC/Line-out and Amplifier 1 * MIC 1 * Line-Out 1 * SPK
<b>COM</b>	4 * RS232 Header 1 * RS232/RS485/RS422 Header 1 * RS232/RS485 Header
<b>USB</b>	7 * USB2.0 Header)
<b>Other Ports</b>	1 * VGA Header 1 * Micro SIM Card Slot 1 * Front Panel Header 1 * GPIO Header
<b>Temperature</b>	Storage: -30~75°C Operating: -20° ~60°C
<b>BIOS</b>	AMI UEFI BIOS
<b>Power Input</b>	DC 12V
<b>Factor</b>	161mm * 106mm

## 2. Data Flow

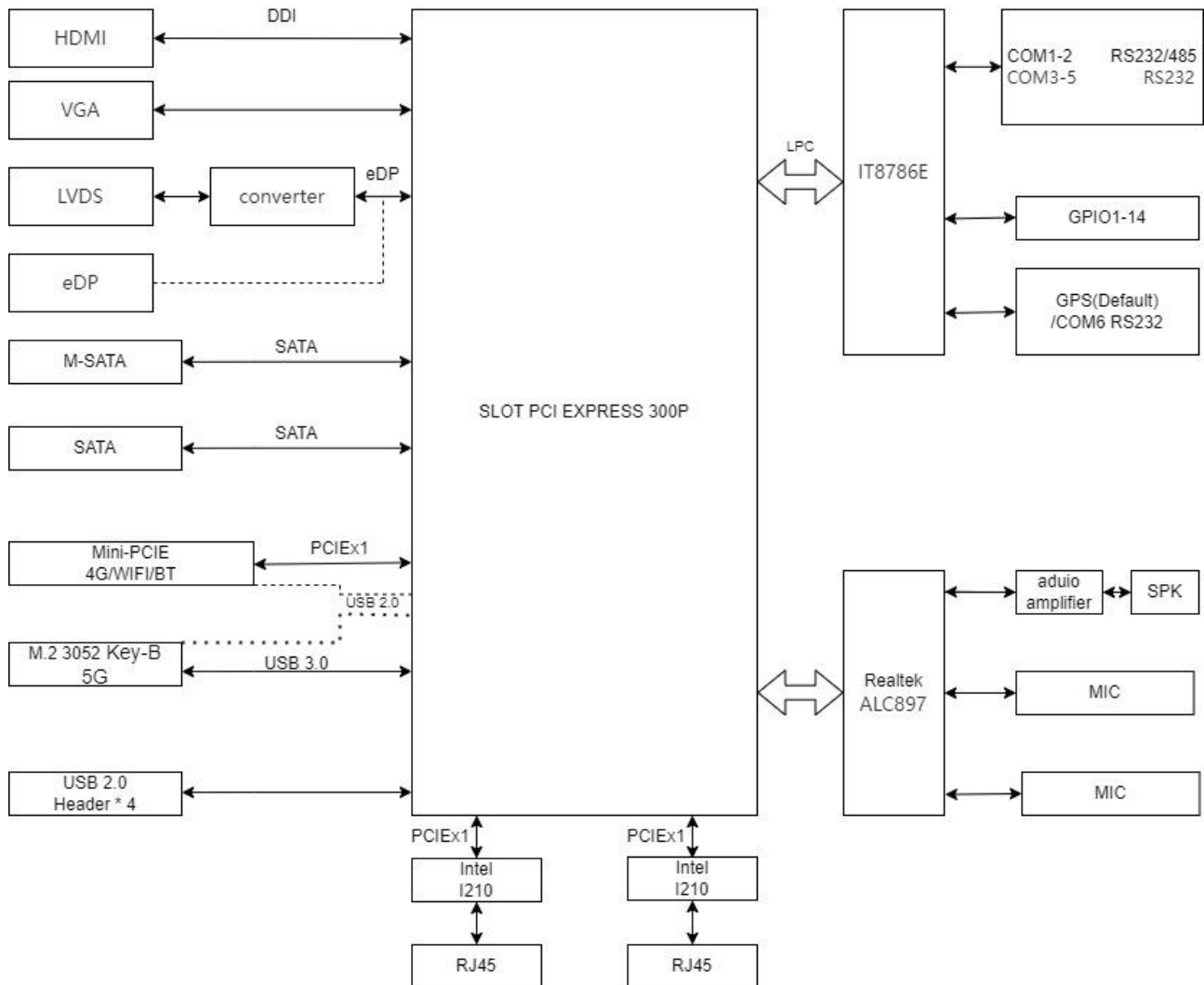

### 3. Marking instruction

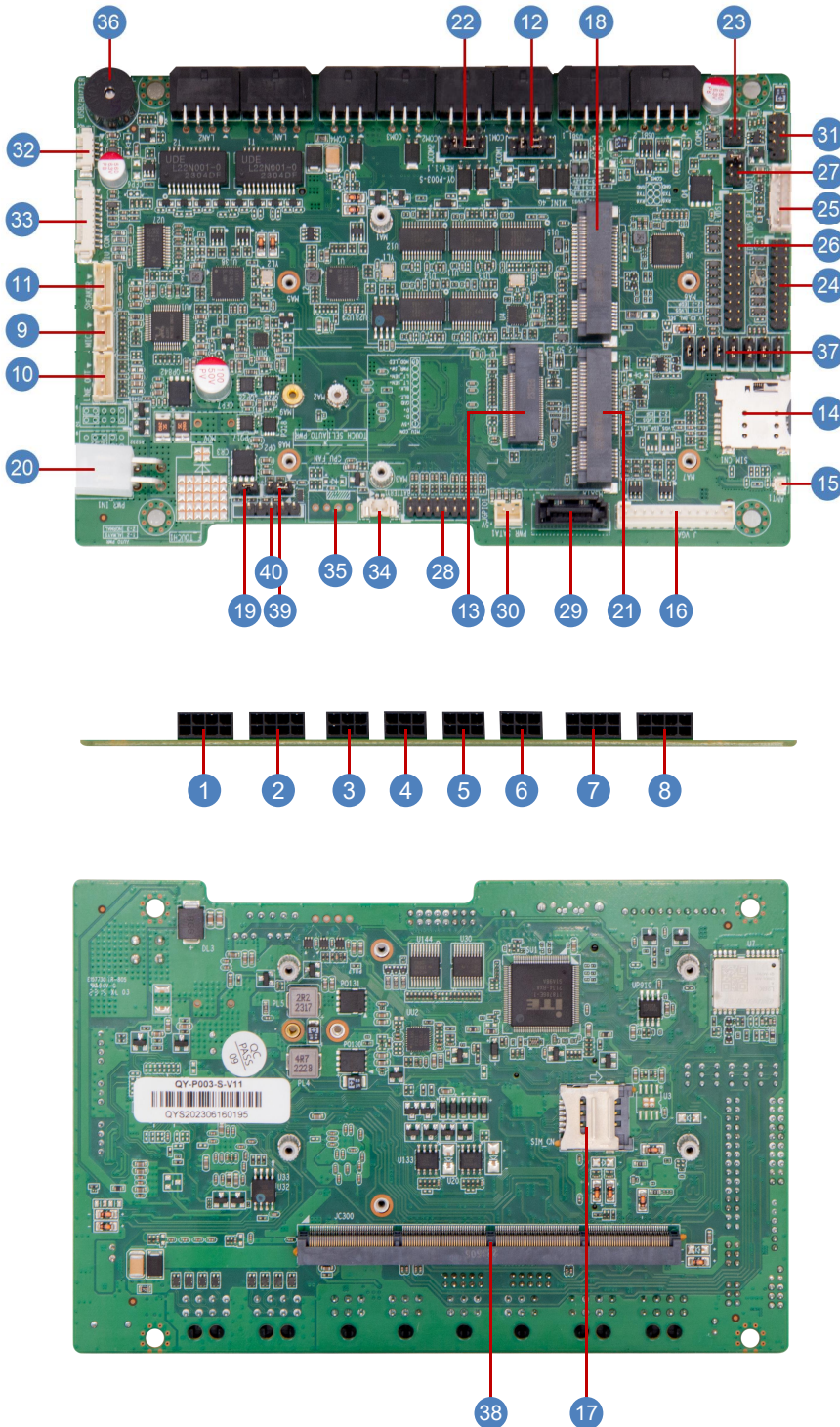

#### Connector&Header

1	USB Pin Header
2	USB Pin Header
3	COM1 Pin Header
4	COM2 Pin Header
5	COM3 Pin Header
6	COM4 Pin Header
7	LAN Pin Header
8	LAN Pin Header
9	MIC Pin Header
10	LINE OUT Pin Header
11	Amplifier Pin Header
12	COM1 Select Jumper
13	M.2 3052 Key-B
14	SIM Card Slot
15	GPS antenna pedestal
16	VGA Pin Headers
17	SIM Card Slot
18	Mini PCI-4G_CAN Slot (WIFI/4G/BT)
19	AUTO SW Select Jumper
20	DC IN Pin Header
21	M-SATA Connector
22	COM2 Select Jumper
23	COM5/6 Pin Header
24	eDP Signal Pin Header
25	eDP/LVDS Backlight Control Pin Header
26	LVDS Signal Pin Header
27	eDP/LVDS VDD Select Jumper
28	GPIO Pin Header
29	SATA 3.0 Connector
30	SATA Power Pin Header
31	USB Pin Headers
32	USB Pin Headers
33	Front Panel Pin Header
34	CMOS battery Holder
35	CPU FAN Pin Header
36	Buzzer
37	eDP/LVDS Signal Select Jumpers
38	SLOT PCI EXPRESS 300P
39	TOUCH_SEL Select Jumper
40	TOUCH Pin Header

## 4. Definition

[1] USB Pin Header (2\*4 3.0mm spacing)

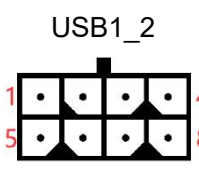
No.	Location	Pin	Definition	Pin	Definition
1		1	+V5S	5	+V5S
		2	USB1_D-	6	USB2_D-
		3	USB1_D+	7	USB1_D+
		4	GND	8	GND

[2] USB Pin Header (2\*4 3.0mm spacing)

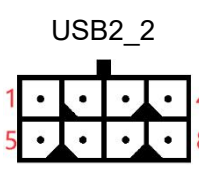
No.	Location	Pin	Definition	Pin	Definition
2		1	+V5S	5	+V5S
		2	USB1_D-	6	USB2_D-
		3	USB1_D+	7	USB1_D+
		4	GND	8	GND

[3] COM1 Pin Header (2\*3 3.0mm spacing)

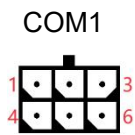
No.	Location	Pin	Definition	Pin	Definition
3		1	COM1_PIN2	4	GND
		2	COM1_PIN3	5	COM1_DSR
		3	COM1_DTR	6	COM1_RTS

[4] COM2 Pin Header (2\*3 3.0mm spacing)

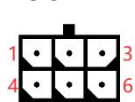
No.	Location	Pin	Definition	Pin	Definition
4		1	COM2_PIN2	4	GND
		2	COM2_PIN3	5	COM2_DSR
		3	COM2_DTR	6	COM2_RTS

[5] COM3 Pin Header (2\*3 3.0mm spacing)

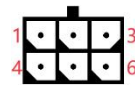
No.	Location	Pin	Definition	Pin	Definition
5		1	COM3_RX	4	GND
		2	COM3_TX	5	COM3_DSR
		3	COM3_DTR	6	COM3_RTS

[6] COM4 Pin Header (2\*3 3.0mm spacing)

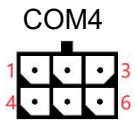
No.	Location	Pin	Definition	Pin	Definition
6		1	COM4_RX	4	GND
		2	COM4_TX	5	COM4_DSR
		3	COM4 DTR	6	COM4_RTS

[7] LAN Pin Header (2\*4 3.0mm spacing)

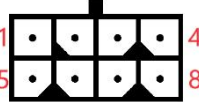
No.	Location	Pin	Definition	Pin	Definition
7		1	D0+	5	D2-
		2	D0-	6	D1-
		3	D1+	7	D3+
		4	D2+	8	D3-

[8] LAN Pin Header (2\*4 3.0mm spacing)

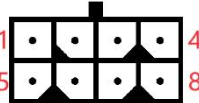
No.	Location	Pin	Definition	Pin	Definition
8		1	D0+	5	D2-
		2	D0-	6	D1-
		3	D1+	7	D3+
		4	D2+	8	D3-

[9] MIC Pin Header(1\*3 Pin 2.0mm )

No.	Location	Pin	Definition	Pin	Definition
9	J_MIC1	1	MIC_L	2	GND
		3	MIC_R		

[10] LINE OUT Pin Header (1\*4 Pin 2.0mm )

No.	Location	Pin	Definition	Pin	Definition
10	LINE OUT	1	OUT_L	2	Sense
		3	OUT_R	4	GND

[11] Amplifier Pin Header (1\*4 Pin 2.00mm Wafer Header)

No.	Location	Pin	Definition	Pin	Definition
11	SPEAKER1	1	SPKR+	2	SPKR-
		3	SPKL-	4	SPKL+

[12] COM1 Select Jumper (2\*9 Pin 2.00mm)

No.	Location	Pin	Definition	Pin	Definition
12	JCOM1	1	COM1_IN	2	COM1_RS485
		3	COM1_IN	4	COM1_RS232(Default)
		5	COM1_TX(Default)	6	COM1_RX(Default)
		7	COM1_PIN3	8	COM1_PIN2
		9	COM1_485_B	10	COM1_485_A

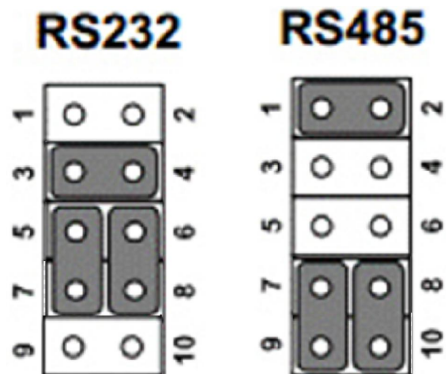

[13] M.2 3052 Key-B

5G module supporting USB3.0 signal, interface M.2 3052 key-B.

[14] SIM Card Slot (Micro SIM)

This SIM card slot corresponds to the 5G module card slot.

[15] GPS antenna pedestal

[16] VGA Pin Headers

No.	Location	Pin	Definition	Pin	Definition
16	J_VGA1	1	GND	2	VSYNC
		3	HSYNC	4	GND
		5	VGA_R	6	GND
		7	VGA_G	8	GND
		9	VGA_B	10	GND
		11	HDMI_I2C_DAT_5V	12	HDMI_I2C_CLK_5V

[17] SIM Card Slot (Micro SIM)

This SIM card slot corresponds to the 4G module card slot.

[18] Mini PCI-4G\_CAN Slot (WIFI/4G/BT)

[19] AUTO SW Select Jumper (2\*6 Pin 2.00mm)

No.	Location	Pin	Definition	Pin	Definition
19	AUTO_PWR	1	AUTO(Default)	2	PWR_SW
		3	+V3.3S		

Note:

[1] This jumper function needs the support of the core module, and some modules may not support this jumper function..

[20] DC IN Pin Header(ATX 4pin)

No.	Location	Pin	Definition	Pin	Definition
20	PWR_IN1	1	GND	2	GND
		3	+12V	4	+12V

[21] M-SATA Connector



[22] COM2 Pin Headers (2\*5 Pin 2.00mm)

No.	Location	Pin	Definition	Pin	Definition
22	J_COM2	1	COM2_IN	2	COM2_RS485
		3	COM2_IN	4	COM2_RS232(Default)
		5	COM2_TX(Default)	6	COM2_RX(Default)
		7	COM2_PIN3	8	COM2_PIN2
		9	COM2_485_B	10	COM2_485_A

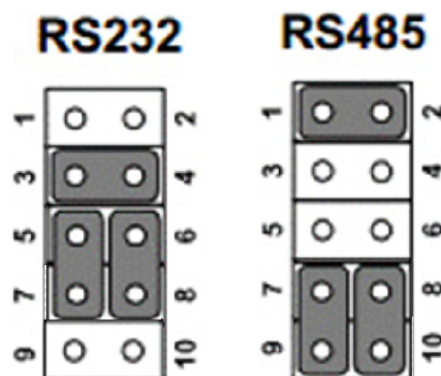

[23] COM5/6 Pin Header (2\*13 Pin 2.00mm)

No.	Location	Pin	Definition	Pin	Definition
23	COM5_6	1	COM5_RX	2	COM6_TX
		3	COM5_TX	4	COM6_TX
		5	GND	6	GND

Note:

[1] COM6 is connected with GPS signal by default, and the COM6 signal of this pin is not connected.

[24] eDP Signal Pin Header (2\*10 Pin 2.00mm)

No.	Location	Pin	Definition	Pin	Definition
24	eDP1	1	LCD_VDD	2	LCD_VDD
		3	GND	4	GND
		5	AUX_CH_N	6	AUX_CH_P
		7	GND	8	GND
		9	N/C	10	N/C
		11	N/C	12	N/C
		13	LANE1_N	14	LANE1_P

		15	LANE0_N	16	LANE0_P
		17	GND	18	GND
		19	N/C	20	HPD

Note:

[1] LV\_EDP\_SEL is the function switching jumper of EDP or LVDS. And only one of them can be used simultaneously. See [37]eDP/LVDS Signal.

[25] eDP/LVDS Backlight Control Pin wafer Header (1\*6 Pin 2.00mm)

No.	Location	Pin	Definition	Pin	Definition
25	BLT_PWR1	1	INVT_PWR	2	INVT_PWR
		3	BLK_EN	4	BLK_PWM
		5	GND	6	GND

[26] LVDS Signal Pin Header (2\*15 Pin 2.00mm)

No.	Location	Pin	Definition	Pin	Definition
26	LVDS1	1	LCD_VDD	2	LCD_VDD
		3	LCD_VDD	4	N/C
		5	GND	6	GND
		7	TA0N-	8	TA0P+
		9	TA1N-	10	TA1P+
		11	TA2N-	12	TA2P+
		13	GND	14	GND
		15	CLK_TAN-	16	CLK_TAP+
		17	TA3N-	18	TA3P+
		19	TB0N-	20	TB0P+
		21	TB1N-	22	TB1P+
		23	TB2N-	24	TB2P+
		25	GND	26	N/C
		27	CLK_TBN-	28	CLK_TBP+
		29	TB3N-	30	TB3P+

Note:

[1] LV\_EDP\_SEL is the function switching jumper of EDP or LVDS. And only one of them can be used simultaneously. See [37]eDP/LVDS Signal.

[27] eDP/LVDS VDD Select Jumper (2\*3 Pin 2.00mm)

No.	Location	Pin	Definition	Pin	Definition
27	JC_LVDS1	1	LCD_VDD(Default)	2	+V3.3S
		3	LCD_VDD	4	+V5S
		5	LCD_VDD	6	+V12S

[28] GPIO Pin Header (2\*8 Pin 2.00mm)

No.	Location	Pin	Definition	Pin	Definition
28	JGPIO1	1	+5VS	2	GND
		3	IN_GP37 (A02.bit7)	4	OUT_GP46 (A03.bit6)
		5	IN_GP36 (A02.bit6)	6	OUT_GP40 (A03.bit0)
		7	IN_GP23 (A01.bit3)	8	OUT_GP10 (A00.bit0)
		9	IN_GP41 (A03.bit1)	10	OUT_GP47 (A03.bit7)
		11	IN_GP65 (A05.bit5)	12	OUT_GP50 (A04.bit0)
		13	IN_GP64 (A05.bit4)	14	OUT_GP33 (A02.bit3)
		15	IN_GP11 (A00.bit1)	16	OUT_GP67 (A05.bit7)

[29] SATA 3.0 Connector

[30] SATA Power Pin wafer Header (1\*4 Pin 2.00mm)

No.	Location	Pin	Definition	Pin	Definition
30	PWR_SATA1	1	GND	2	+ 5V

[31] USB Pin Headers (2\*5 Pin 2.00mm)

No.	Location	Pin	Definition	Pin	Definition
31	F_USB1	1	+5VS	2	+5VS
		3	Data0-	4	Data1+
		5	Data0+	6	Data1+
		7	GND	8	GND
				10	N/C

[32] USB Pin Headers (2\*5 Pin 2.00mm)

No.	Location	Pin	Definition	Pin	Definition
32	F_USB2	1	+5VS	2	Data0-
		3	Data0+	4	GND

[33] Front Panel Pin Header (2\*5 Pin 2.00mm)

No.	Location	Pin	Definition	Pin	Definition
33	MIU_CON	1	+5VS	2	USB_Data0-
		3	USB_Data0+	4	GND
		5	BKL_DOWN	6	BKL_UP
		7	BKL_DOWN	8	BKL_UP
		9	PWR_SW	10	HDD_LED(Default)/RTS_SW

Note:

[1] The default configuration of the 10-pin is HDD\_LED.

[34] CMOS battery Holder

[35] CPU Fan Header (4\*1 Pin 2.54mm)

No.	Location	Pin	Definition	Pin	Definition
35	CPU_FAN1	1	GND	2	+ 12V
		3	FAN Speed Detection	4	FAN Speed Control

[36] Buzzer

[37] eDP/LVDS Signal Select Jumpers (1\*3 Pin 2.00mm\*7 pairs)

Jump 1-2pin for LVDS signal output, and jump 2-3pin for eDP signal output. Default 1-2pin LVDS signal output.

[38] SLOT PCI EXPRESS 300P

Our company specially defines the extension interface, and it is forbidden to use non-core module products.

[39] TOUCH\_SEL Select Jumper (1\*3 Pin 2.00mm)

No.	Location	Pin	Definition	Pin	Definition
38	TOUCH_SEL1	1	N/C	2	Y-
		3	Sense		

[40] TOUCH Pin Header (1\*5 Pin 2.54mm)

No.	Location	Pin	Definition	Pin	Definition
39	F_TOUCH1	1	Y+	2	X+
		3	Sense	4	Y-
		5	X-		

【 END 】

## 免责声明

本手册为北京启阳科技有限公司版权所有，未经许可不得以任何方式复制。本手册内容并不代表本公司的承诺，由于本公司对产品的不断改进，本公司保留对此手册升级和更改的权利，恕不另行通知。以实物为准，对于任何因安装、使用不当而导致的直接、间接、有意或无意的损坏及隐患概不负责。

保修条款：

用户如另有要求，以双方签署的合同为准。

商标

本手册使用的所有商标均为各自的商标所有者所有：

AMI®是AMI公司的注册商标。

Intel®,Core®,Celeron®,Pentium®,ATOM®是Intel公司的注册商标。

Realtek®是Realtek公司的注册商标。

PS/2和OS/2是International Business Machines公司的注册商标。

Windows 7, windows 8, windows 10, windows 11是Microsoft公司的注册商标。

安全提示

1. 产品使用前，务必请仔细阅读安全手册，并妥善保管以便日后参考。
2. 当您给设备供电前，请确认电源电压是否符合设备要求。
3. 为避免人体被电击或产品被损坏，用洗板水或电路板专用电路板清洁剂前，请从插座上拔下电源线
4. 请不要使用液体或去污喷雾剂去清洗设备。
5. 请不要让任何液体流入或溅入到设备内部，以免引起短路或者火灾。
6. 对于使用电源线的设备，设备周围必须有容易接触到的电源插座。
7. 请不要在潮湿环境中使用设备。
8. 请在安装前确保设备放置在可靠的平面上，意外跌落或翻倒可能会导致设备故障或损坏。
9. 当需连接或拔除任何信号线前，须确定所有的电源线事先已被拔掉。
10. 为避免频繁开关机对产品造成不必要的损伤，关机后，应至少等待30秒后再开机。
11. 如果长时间不使用设备，请断开电源线，避免设备被瞬间电压损坏。
12. 如果要进行升级或拆装等动作，须在静电放电工作台上完成所有操作，因为有些精密器件对静电放电（ESD）很敏感。
13. 保证系统良好的散热与通风。
14. 请不要自行拆卸设备，为了安全起见，此设备只能交由专业维修人员。